

QuickField simulation report

Electric circuit analysis

Calculate currents and voltages in the circuit elements, check the power balance.

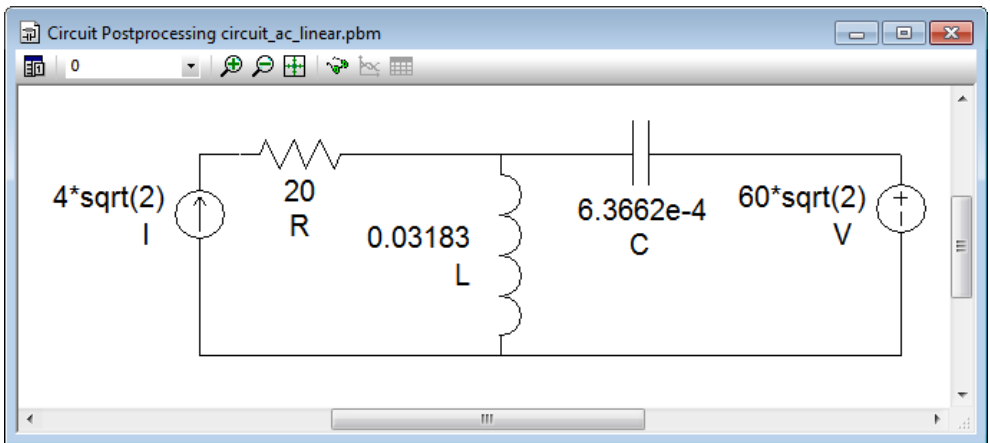

This automatically generated document consists of several sections, which specify the problem setup and finite element analysis simulation results. Navigation links in the top of each page lead to corresponding sections of this report.

Problem description and QuickField simulation files:

https://quickfield.com/advanced/circuit_linear_ac.htm

Problem info

Problem type: AC Magnetics , frequency: 50 Hz,

Geometry model class: Plane-Parallel

Problem database file names:

- Problem: *circuit_ac_linear.pbm*
- Geometry: *Circuit_ac_linear.mod*
- Material Data: *Circuit_ac_linear.dhe*
- Material Data 2 (library): *none*
- Electric circuit: *circuit_ac_linear.qcr*

Results taken from other problems:

- *none*

Geometry model

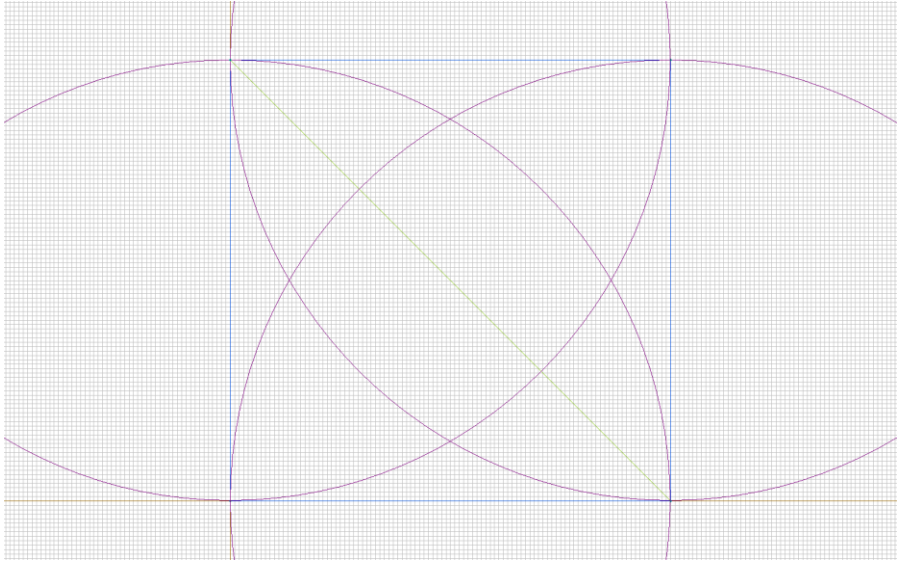

Table 1. Geometry model statistics

	With Label	Total
Blocks	1	1
Edges	1	4
Vertices	0	4

Number of nodes: 4.

Electric circuit

Coupled electric circuit

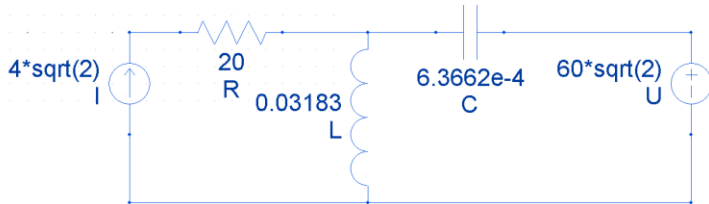

Circuit elements:

Voltage source $U=60*\sqrt{2}$ [V] 30 [deg]

Capacitor $C=0.00063662$ [F]

Inductor $L=0.03183$ [H]

Resistor $R=20$ [Ohm]

Current source $I=4*\sqrt{2}$ [A] 0 [deg]

Labelled objects

There are following labelled objects in the geometry model (Material Data file could contain more labels, but only those labels that assigned to geometric objects are listed)

Blocks:

- [Block1](#)
-

Edges:

- [Edge1](#)
-

Vertices:

Detailed information about each label is listed below.

Labelled objects: block "Block1"

There are (1) objects with this label

Relative magnetic permeability: $\mu_x=1$, $\mu_y=1$

Electric conductivity: $\sigma=0$ [S/m]

Current density: $j=0$ [A/m²], phase 0 [deg]

Conductor's connection: in parallel

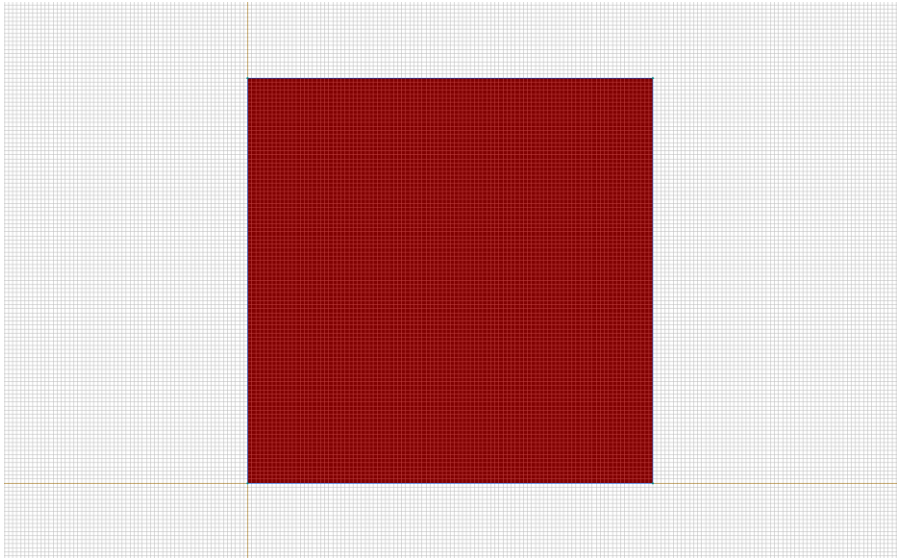

Labelled objects: edge "Edge1"

There are (4) objects with this label

Magnetic potential: $A=0$ [Wb/m], phase 0 [deg]

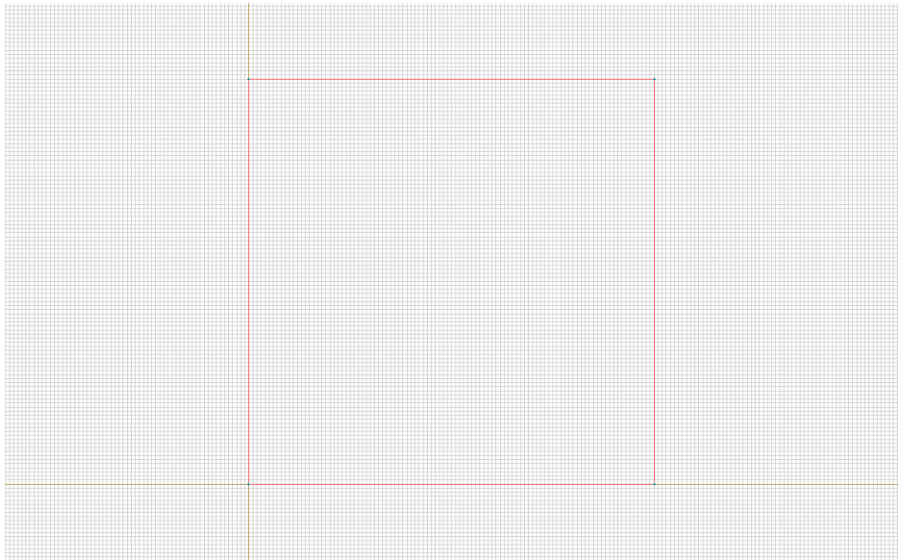

Results

Field lines



Results

Electric circuit currents

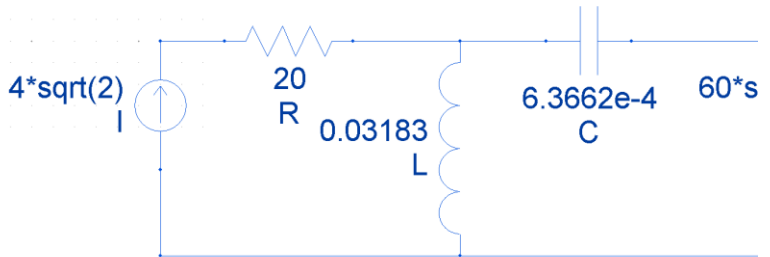

Circuit elements:

U. $I=14.967$ [A], phase= -100.89 [deg]

C. $I=14.967$ [A], phase= 79.11 [deg]

L. $I=14.968$ [A], phase= 100.89 [deg]

R. $I=5.657$ [A], phase= 180 [deg]

I. $I=5.657$ [A], phase= 0 [deg]

Results

Color map of Strength $|H|$ [A/m]

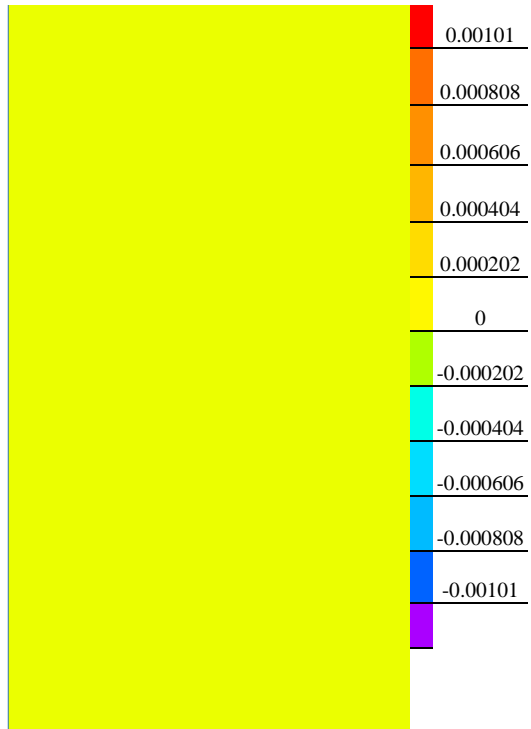

Nonlinear dependencies

No non-linear dependencies are used in this problem data

