

Problem info

Problem type: AC Magnetics , frequency: 50 Hz,

Geometry model class: Plane-Parallel

Problem database file names:

- Problem: *concrete_rebar_side_window.pbm*
- Geometry: *Concrete_rebar_side_window.mod*
- Material Data: *Concrete_rebar_side_window.dhe*
- Material Data 2 (library): *none*
- Electric circuit: *none*

Results taken from other problems:

- *none*

Geometry model

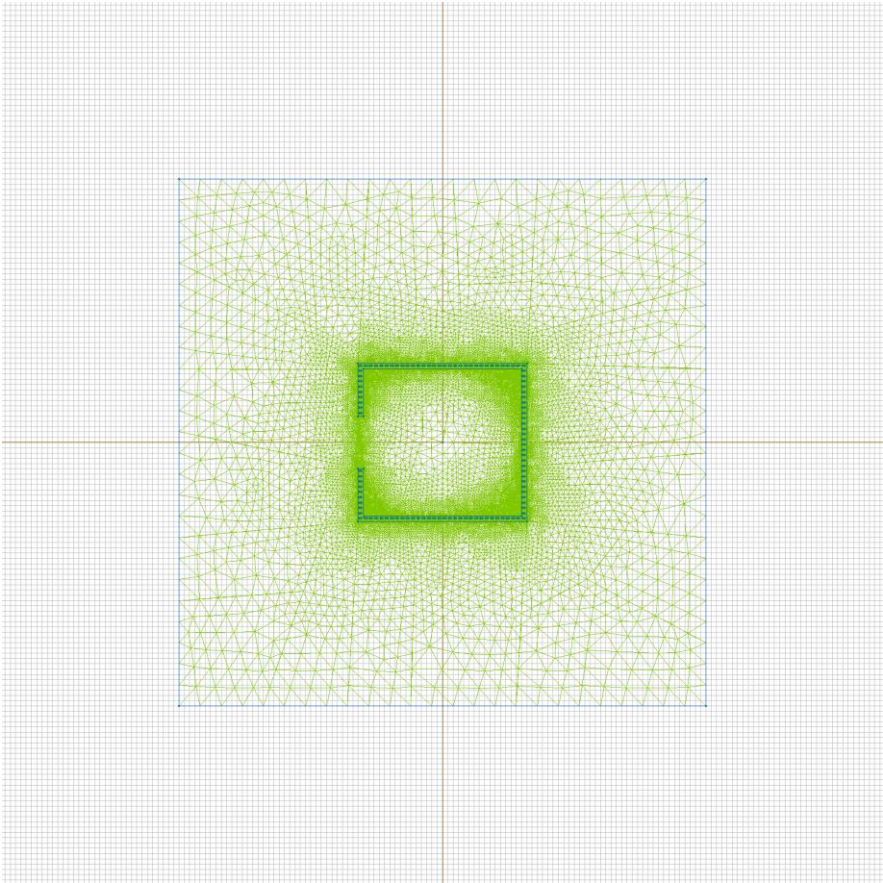

Table 1. Geometry model statistics

	With Label	Total
Blocks	3	112
Edges	4	236
Vertices	1	237

Number of nodes: 22886.

Labelled objects

There are following labelled objects in the geometry model (Material Data file could contain more labels, but only those labels that assigned to geometric objects are listed)

Blocks:

- [concrete](#)
- [rebar](#)
- [air](#)
-

Edges:

- [top](#)
- [bottom](#)
- [right](#)
- [left](#)
-

Vertices:

- [test_pt](#)
-

Detailed information about each label is listed below.

Labelled objects: block "concrete"

There are (1) objects with this label

Relative magnetic permeability: $\mu_x=1$, $\mu_y=1$

Electric conductivity: $\sigma=0.01$ [S/m]

Current density: $j=0$ [A/m²], phase 0 [deg]

Conductor's connection: in parallel

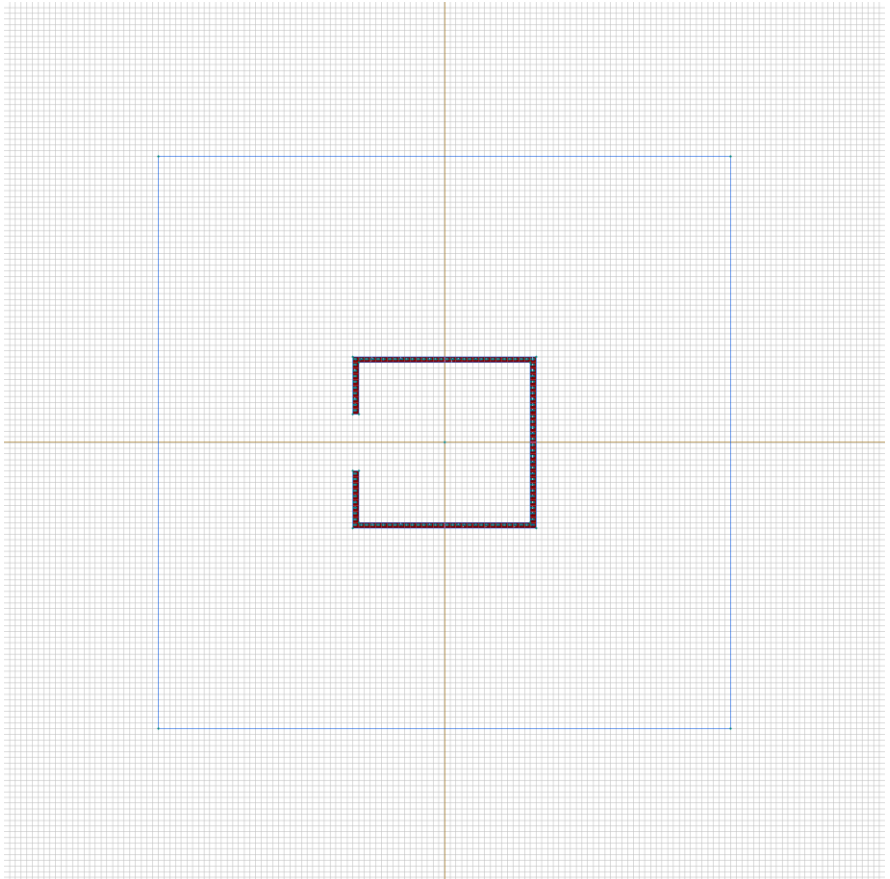

Labelled objects: block "rebar"

There are (110) objects with this label

Relative magnetic permeability: $\mu_x=100$, $\mu_y=100$

Electric conductivity: $\sigma=1700000$ [S/m]

Current density: $j=0$ [A/m²], phase 0 [deg]

Conductor's connection: in parallel

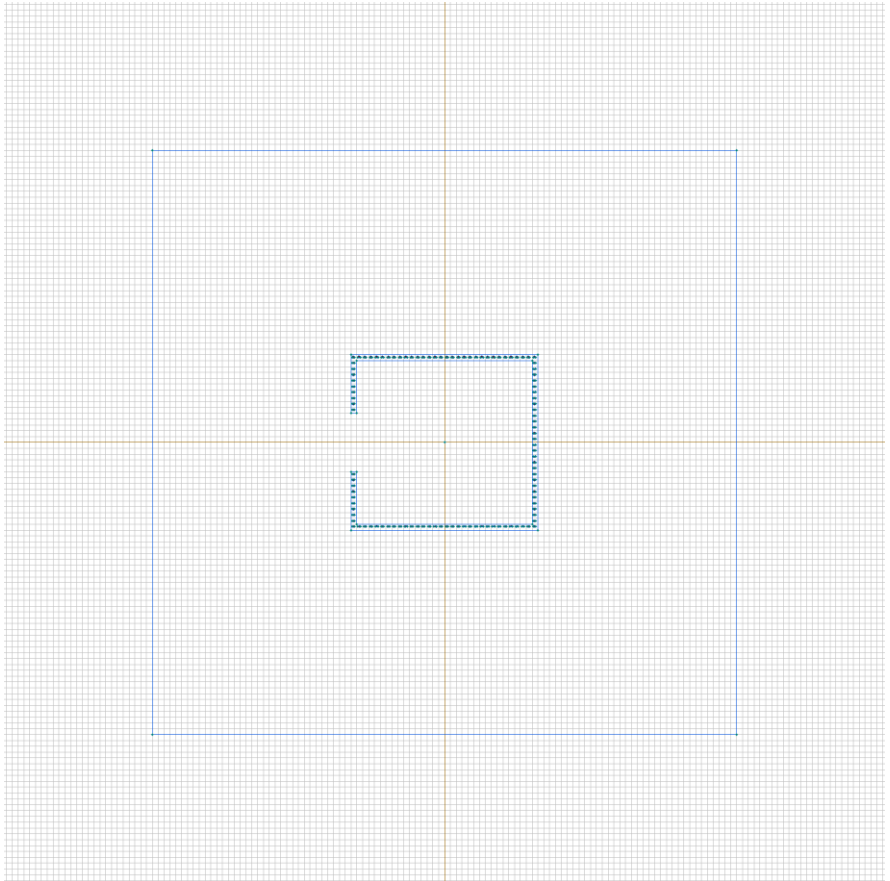

Labelled objects: block "air"

There are (1) objects with this label

Relative magnetic permeability: $\mu_x=1$, $\mu_y=1$

Electric conductivity: $\sigma=0$ [S/m]

Current density: $j=0$ [A/m²], phase 0 [deg]

Conductor's connection: in parallel

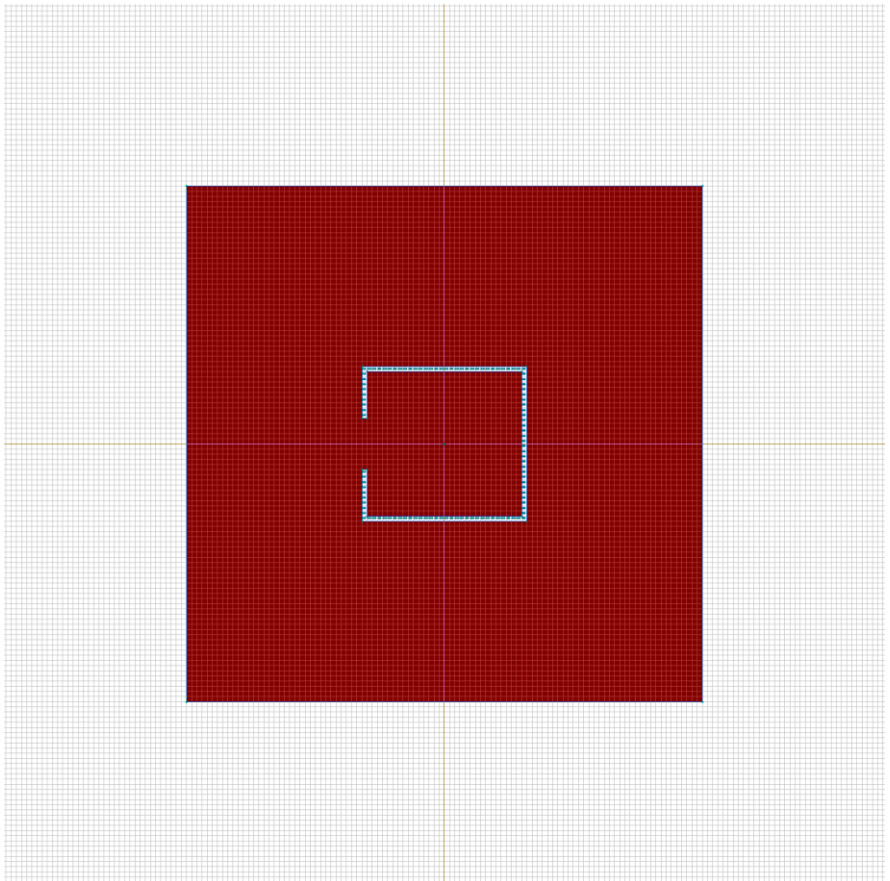

Labelled objects: edge "top"

There are (1) objects with this label

Tangential field: $H_t=0$ [A/m], phase 0 [deg]

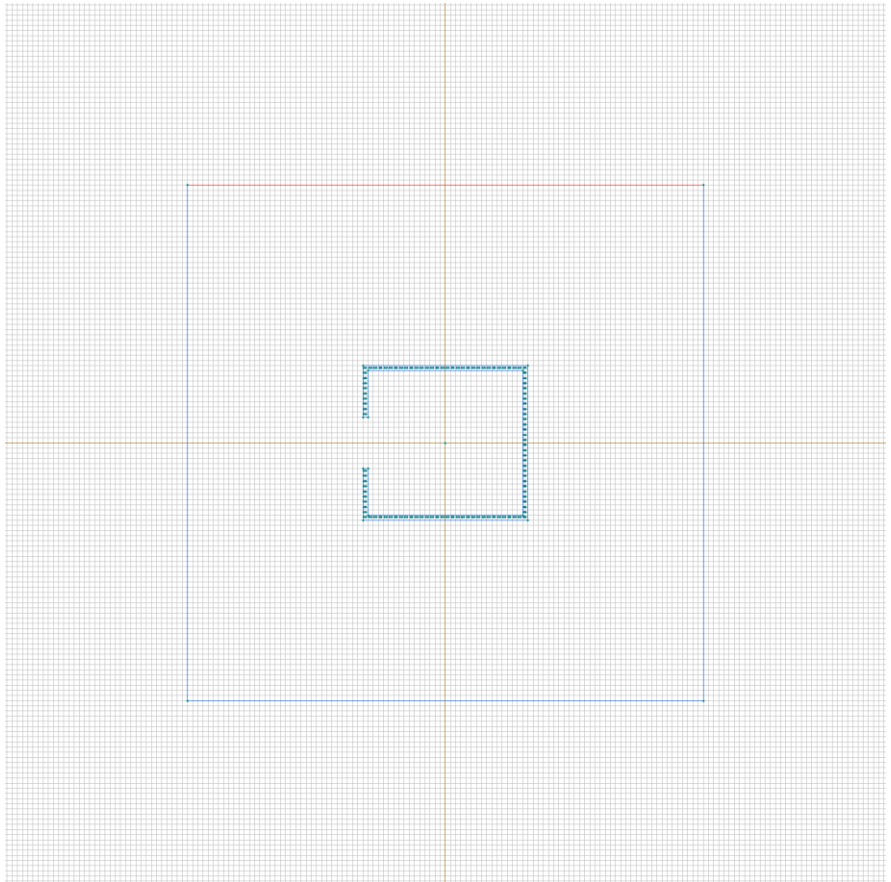

Labelled objects: edge "bottom"

There are (1) objects with this label

Tangential field: $H_t=0$ [A/m], phase 0 [deg]

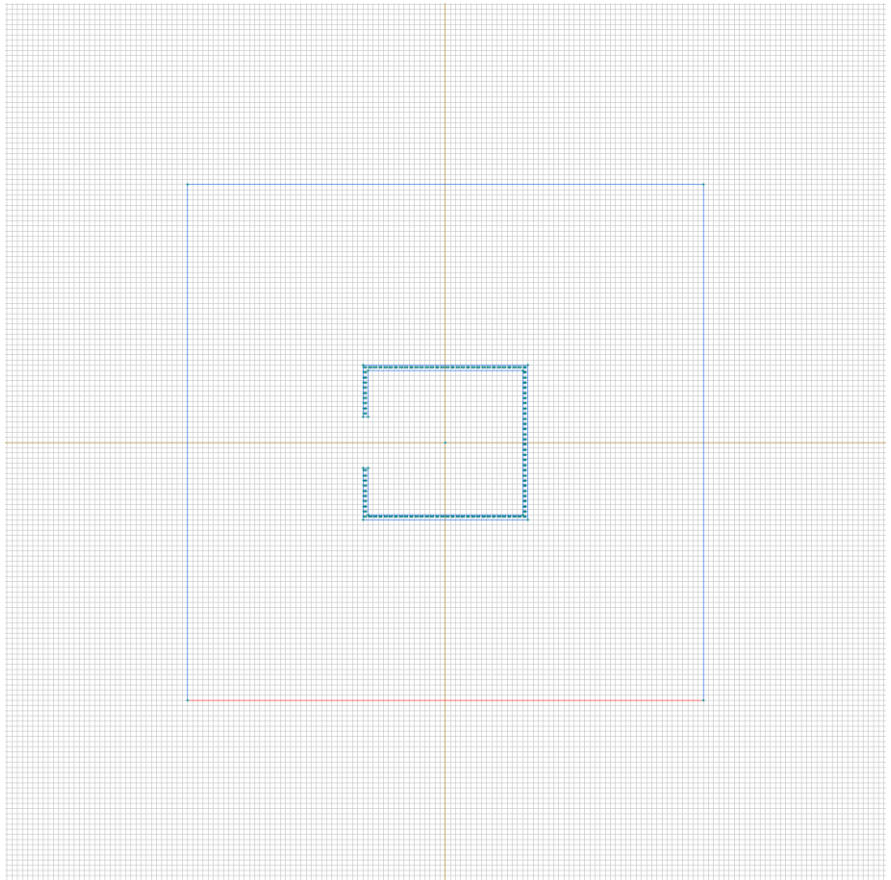

Labelled objects: edge "right"

There are (1) objects with this label

Magnetic potential: $A=1$ [Wb/m], phase 0 [deg]

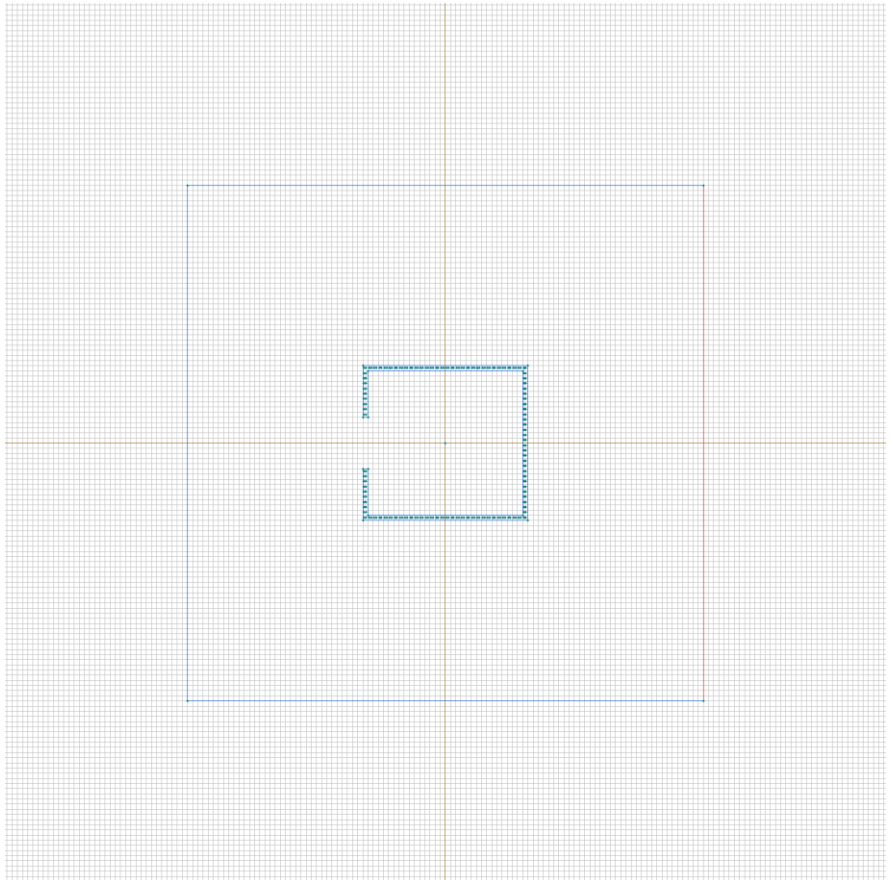

Labelled objects: edge "left"

There are (1) objects with this label

Magnetic potential: $A=-1$ [Wb/m], phase 0 [deg]

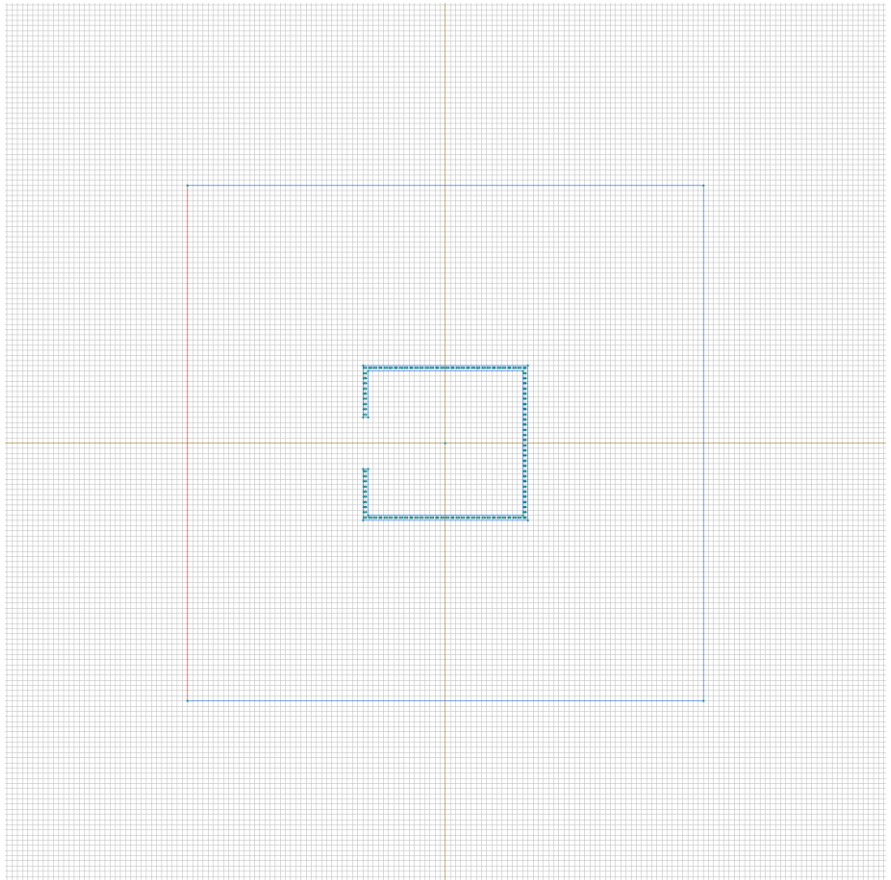

Labelled objects: vertex "test_pt"

There are (1) objects with this label

No material data (boundary conditions) are specified

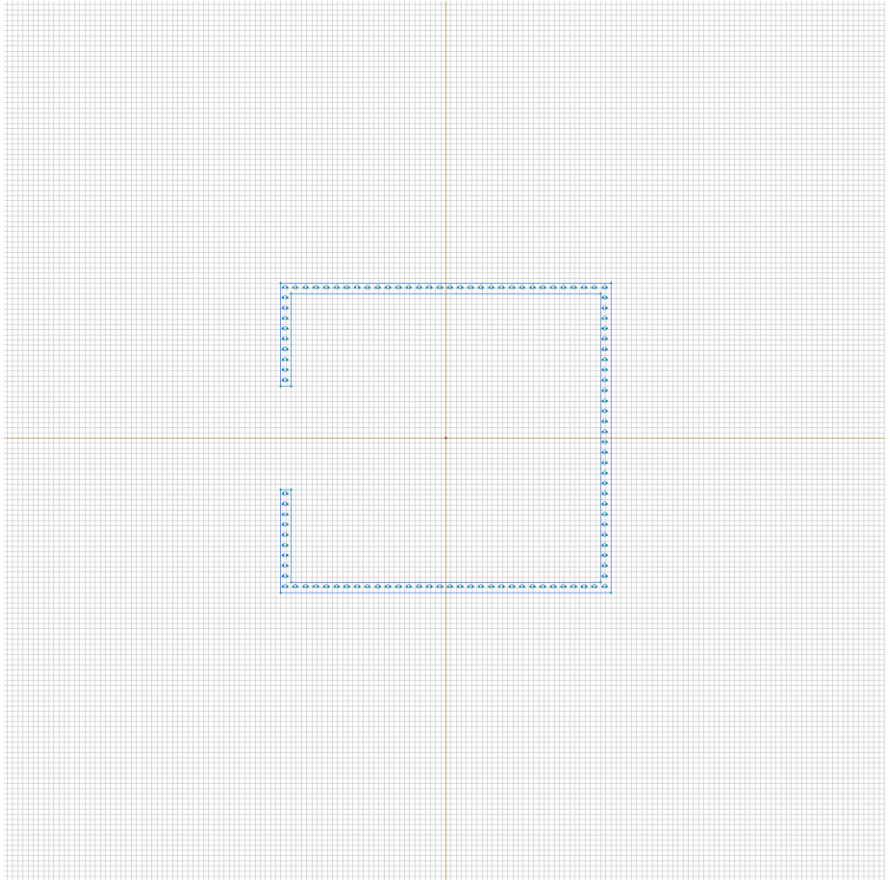

Results

Field lines

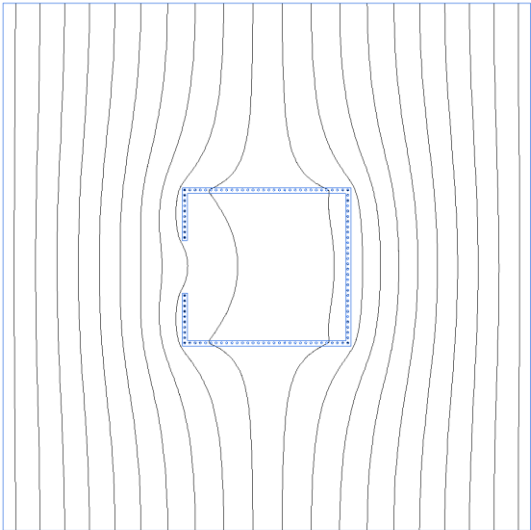

Results

Color map of Strength $|H|$ [A/m]

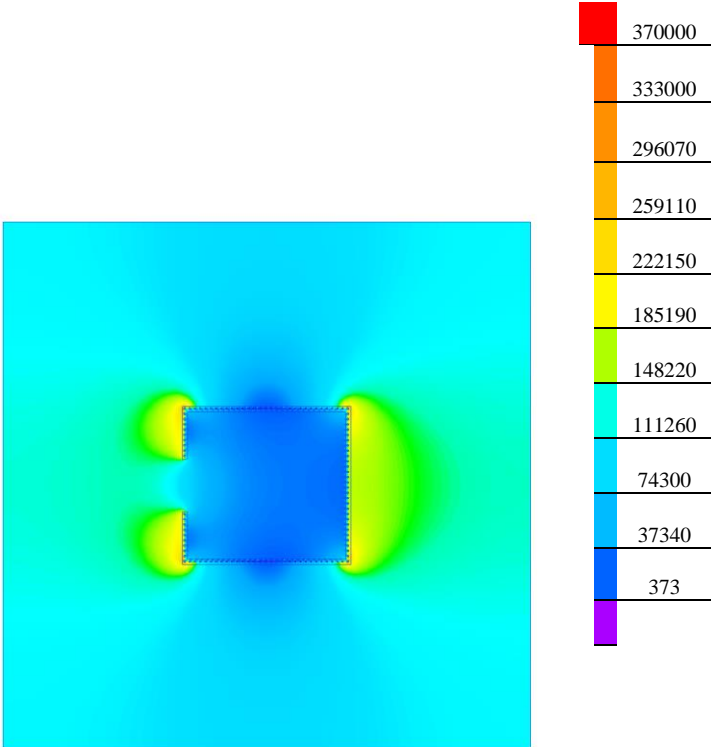

Nonlinear dependencies

No non-linear dependencies are used in this problem data