

# QuickField simulation report

## Maxwell coil

Calculate the flux density distribution within the Maxwell coil. Find the area of uniform field.

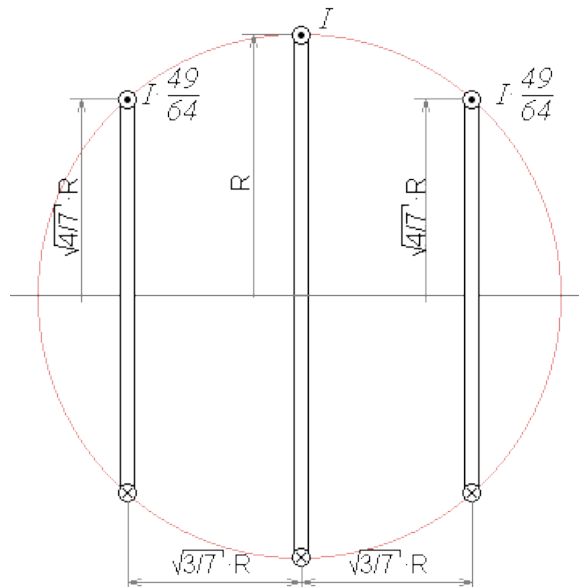

This automatically generated document consists of several sections, which specify the problem setup and finite element analysis simulation results. Navigation links in the top of each page lead to corresponding sections of this report.

Problem description and QuickField simulation files:  
[https://quickfield.com/advanced/maxwell\\_coils.htm](https://quickfield.com/advanced/maxwell_coils.htm)

# Problem info

Problem type: Magnetostatics

Geometry model class: Axisymmetric

Problem database file names:

- Problem: *MaxwellCoils.pbm*
- Geometry: *Maxwellcoils.mod*
- Material Data: *Maxwellcoils.dms*
- Material Data 2 (library): *none*
- Electric circuit: *none*

Results taken from other problems:

- *none*

# Geometry model

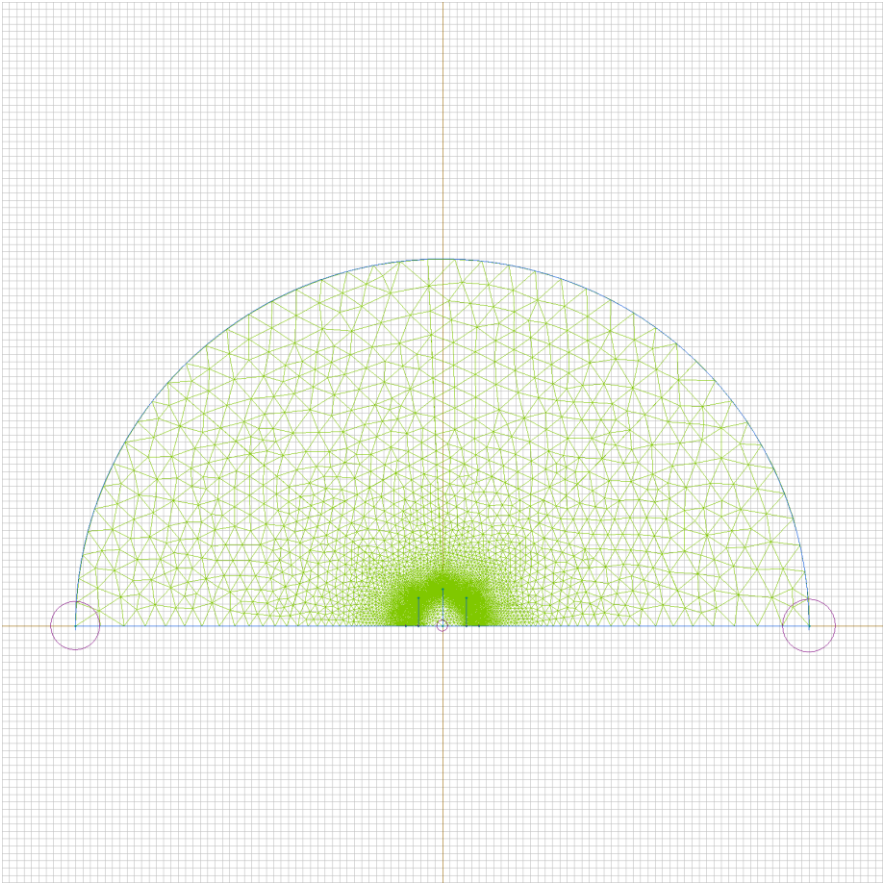

Table 1. Geometry model statistics

	With Label	Total
Blocks	1	1
Edges	1	10
Vertices	3	10

Number of nodes: 16905.

# Labelled objects

There are following labelled objects in the geometry model (Material Data file could contain more labels, but only those labels that assigned to geometric objects are listed)

Blocks:

- [air](#)
- 

Edges:

- [ext](#)
- 

Vertices:

- [Coil2](#)
- [Coil3](#)
- [Coil1](#)
- 

Detailed information about each label is listed below.

Labelled objects: block "air"

There are (1) objects with this label

Relative magnetic permeability:  $\mu_x=1$ ,  $\mu_y=1$

Current density:  $j=0$  [A/m<sup>2</sup>]

Conductor's connection: in parallel

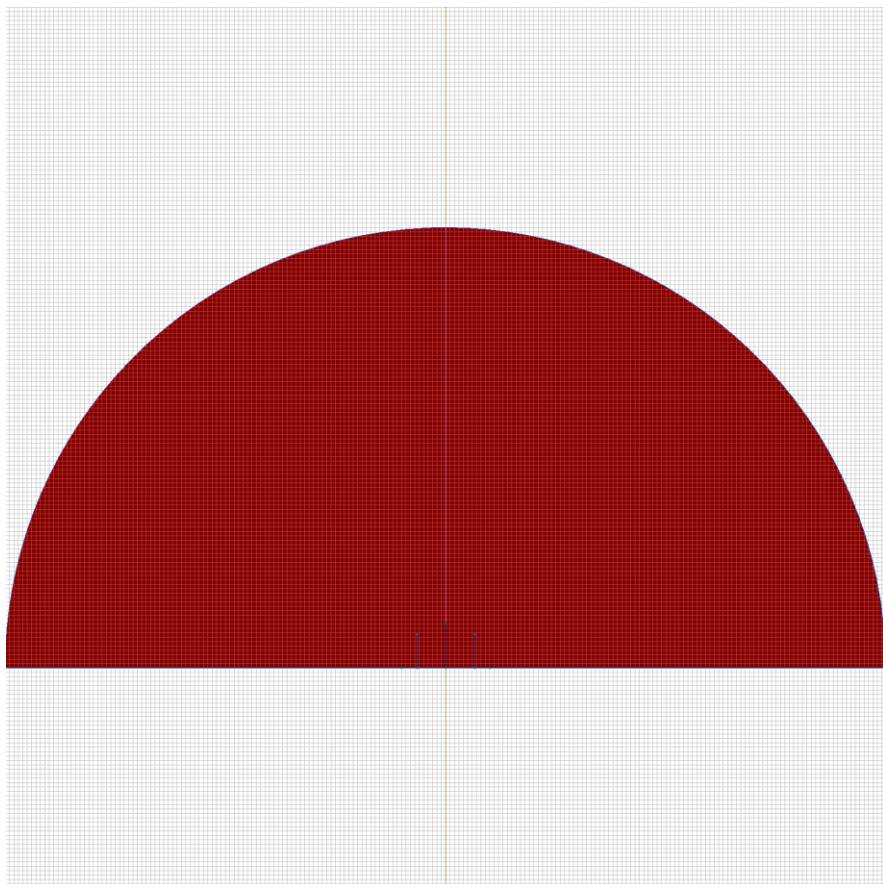

Labelled objects: edge "ext"

There are (1) objects with this label

Magnetic potential:  $A=0$  [Wb/m]

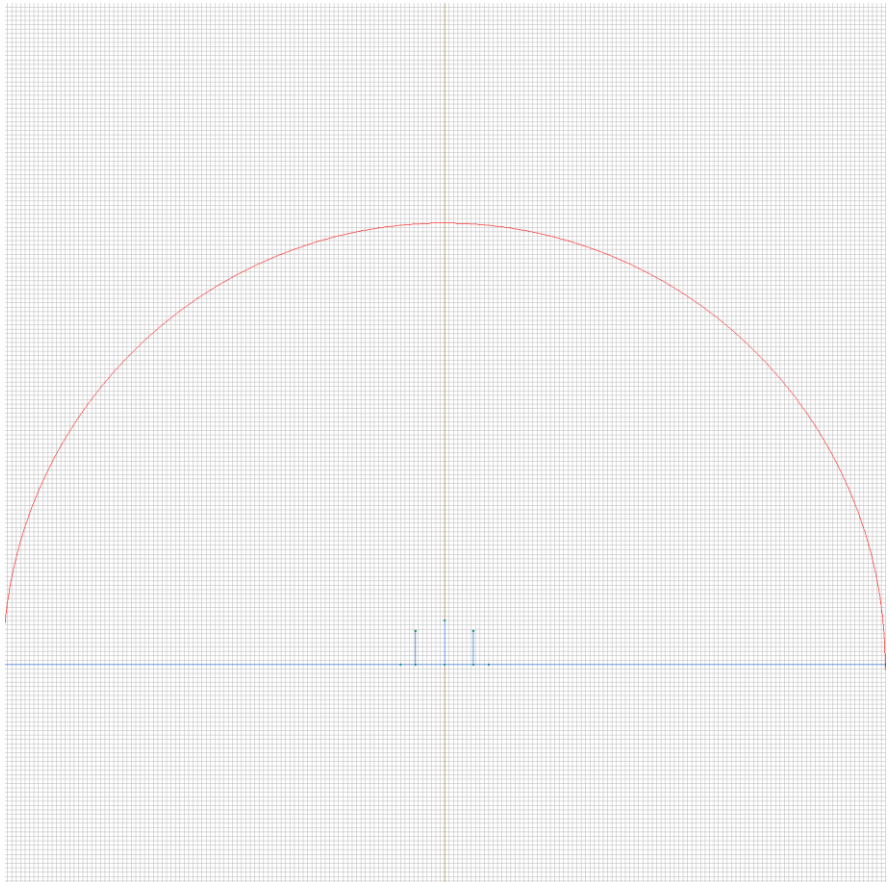

Labelled objects: vertex "Coil2"

There are (1) objects with this label

Linear current:  $I = 1$  [A]

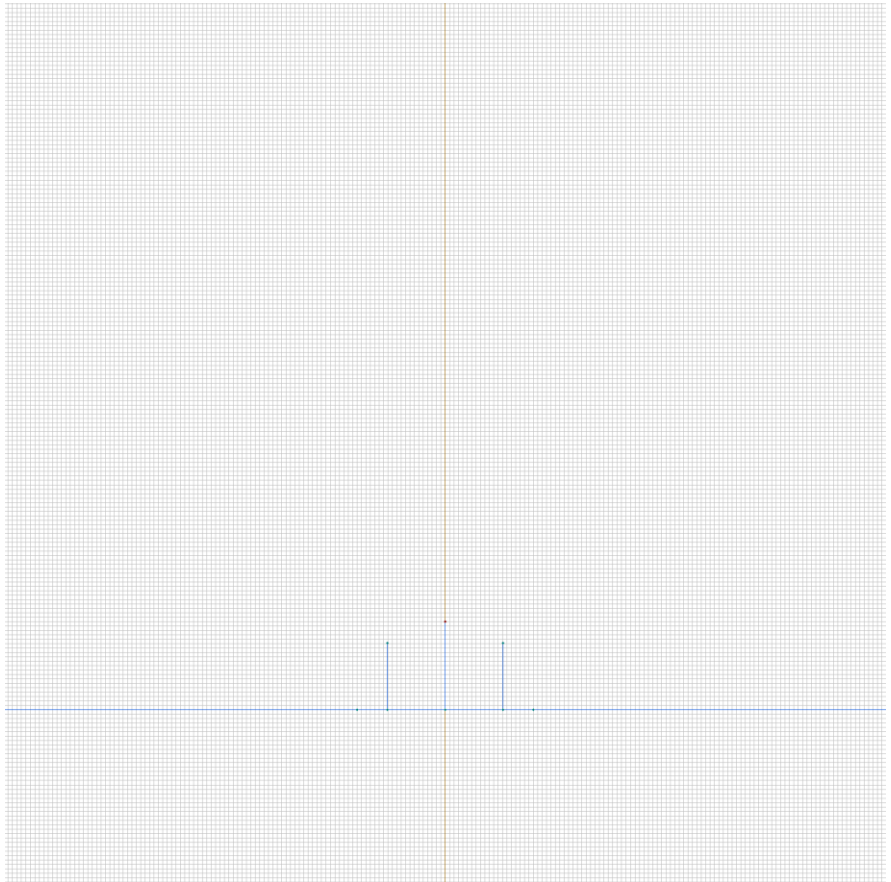



Labelled objects: vertex "Coil3"

There are (1) objects with this label

Linear current:  $I = 49/64$  [A]

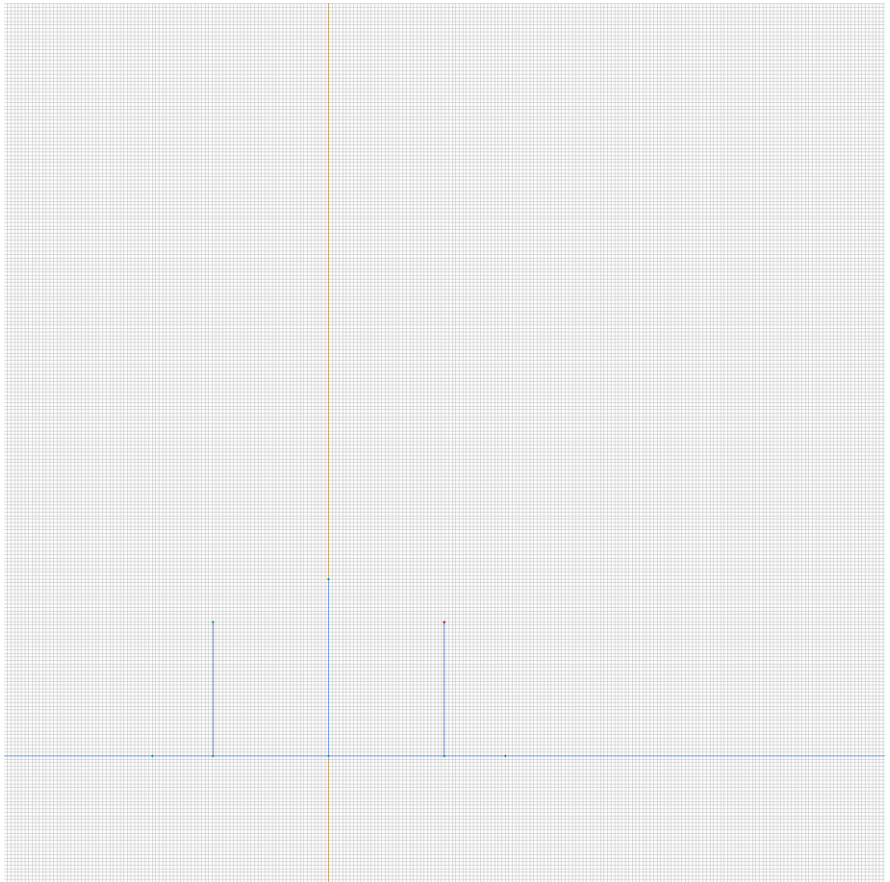

Labelled objects: vertex "Coil1"

There are (1) objects with this label

Linear current:  $I = 49/64$  [A]







# Results

Field lines

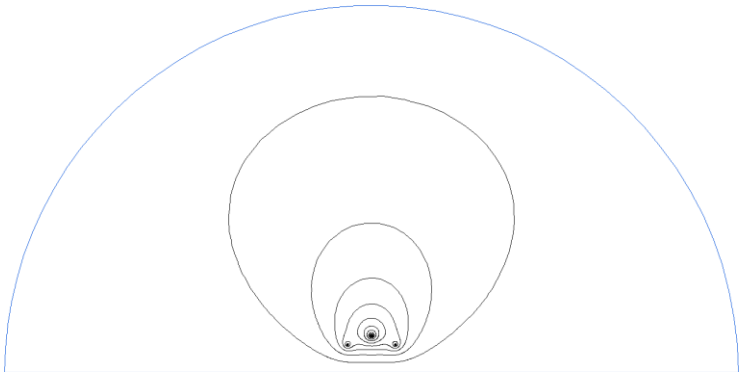

# Results

Color map of Strength  $|H|$  [A/m]

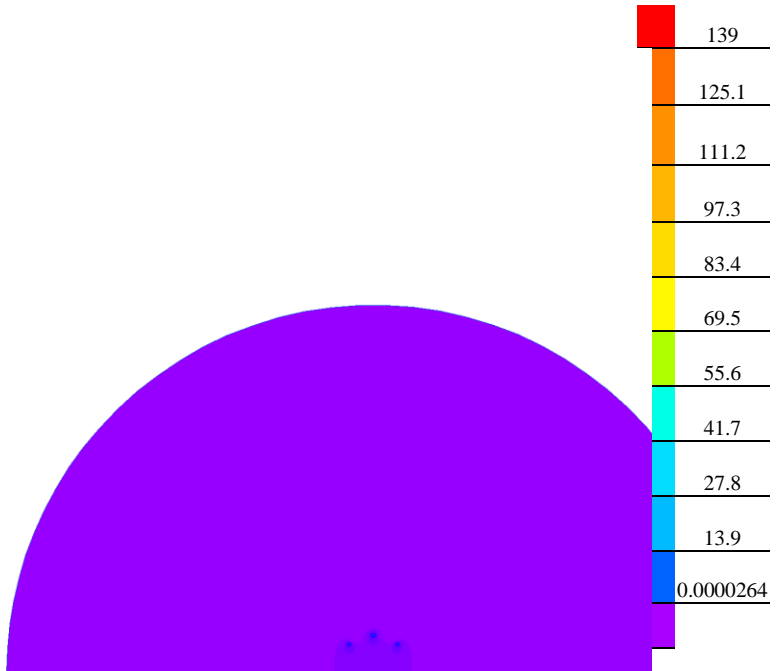

# Nonlinear dependencies

No non-linear dependencies are used in this problem data