

QuickField simulation report

Vessel

Thermal insulating vessel (thermal conductivity of the material is given) separates a heated agent from the ambient space so that temperature difference between its internal and external sides is 220°C

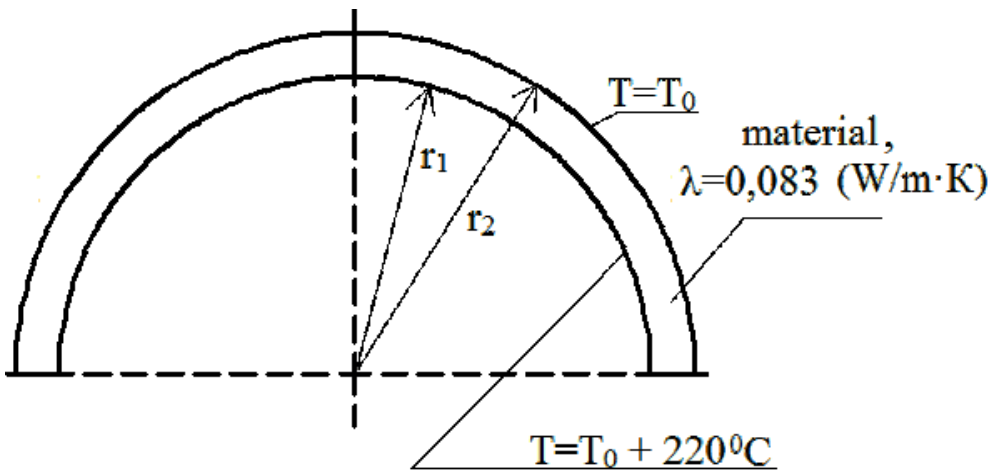

This automatically generated document consists of several sections, which specify the problem setup and finite element analysis simulation results. Navigation links in the top of each page lead to corresponding sections of this report.

Problem description and QuickField simulation files:

<https://quickfield.com/advanced/vessel.htm>

Problem info

Problem type: Steady-State Heat Transfer

Geometry model class: Axisymmetric

Problem database file names:

- Problem: *vessel.pbm*
- Geometry: *Vessel.mod*
- Material Data: *Vessel.dht*
- Material Data 2 (library): *none*
- Electric circuit: *none*

Results taken from other problems:

- *none*

Geometry model

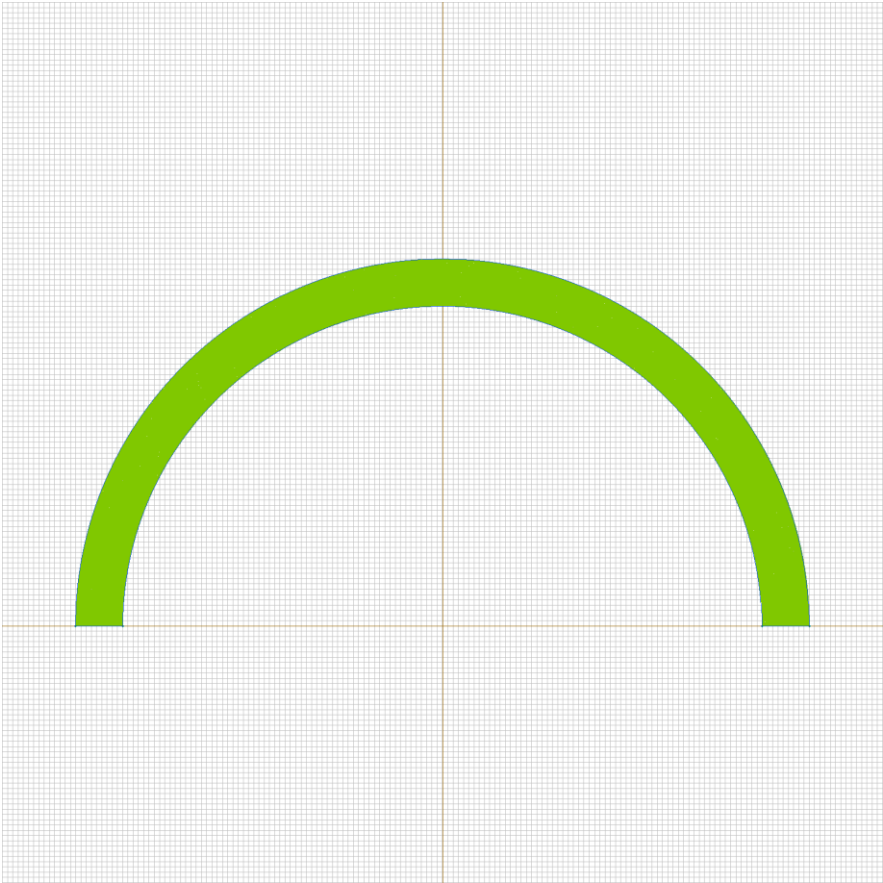

Table 1. Geometry model statistics

	With Label	Total
Blocks	1	1
Edges	3	4
Vertices	0	4

Number of nodes: 242112.

Labelled objects

There are following labelled objects in the geometry model (Material Data file could contain more labels, but only those labels that assigned to geometric objects are listed)

Blocks:

- [material](#)
-

Edges:

- [F=0](#)
- [inside](#)
- [outside](#)
-

Vertices:

Detailed information about each label is listed below.

Labelled objects: block "material"

There are (1) objects with this label

Thermal conductivity: $\lambda_x=0.083$ [W/(K*m)],
 $\lambda_y=0.083$ [W/(K*m)]

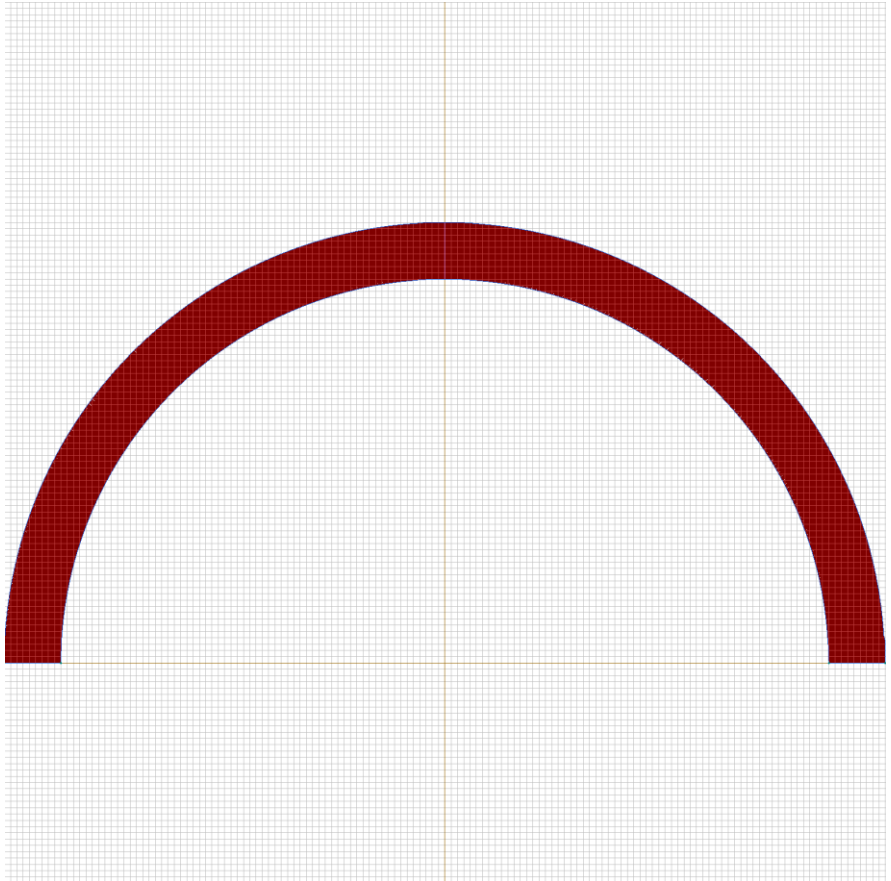

Labelled objects: edge "F=0"

There are (2) objects with this label

Heat flux: $F=0$ [W/m²]

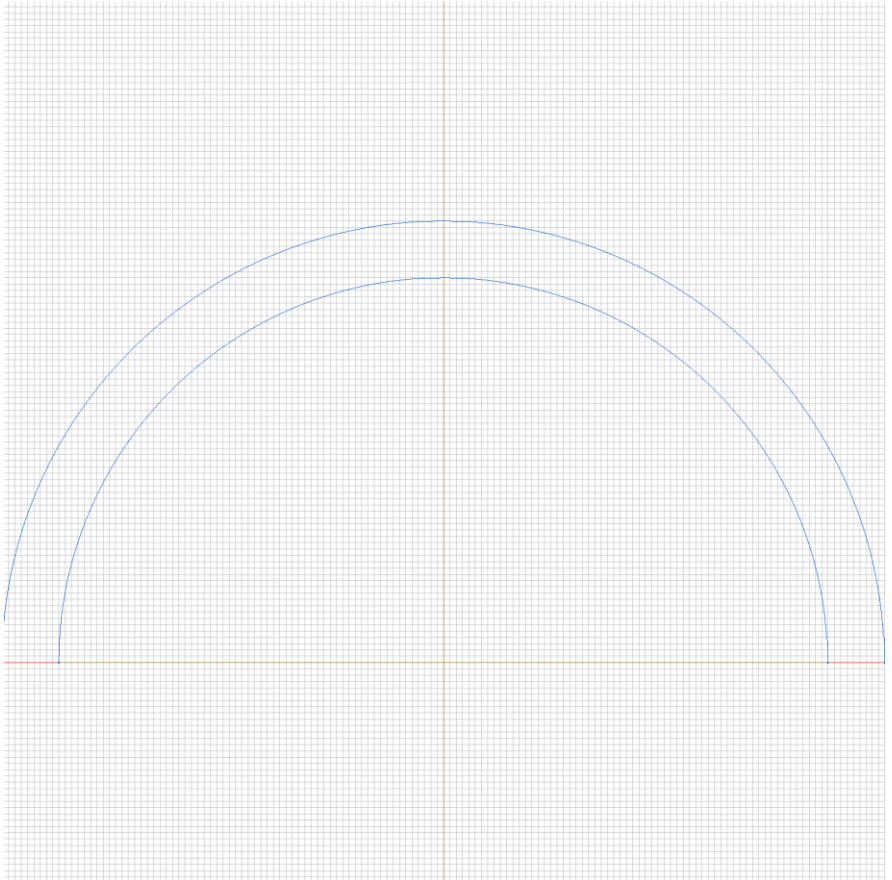

Labelled objects: edge "inside"

There are (1) objects with this label

Temperature: $T = -53.15$ [K]

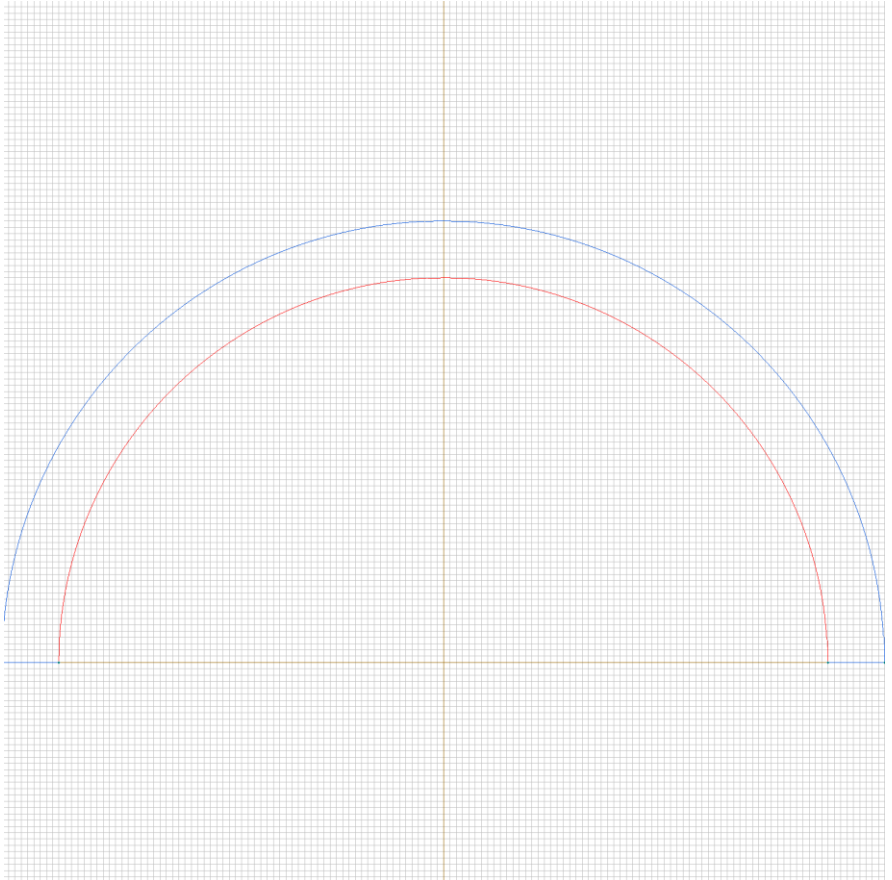

Labelled objects: edge "outside"

There are (1) objects with this label

Temperature: $T = -273.15$ [K]

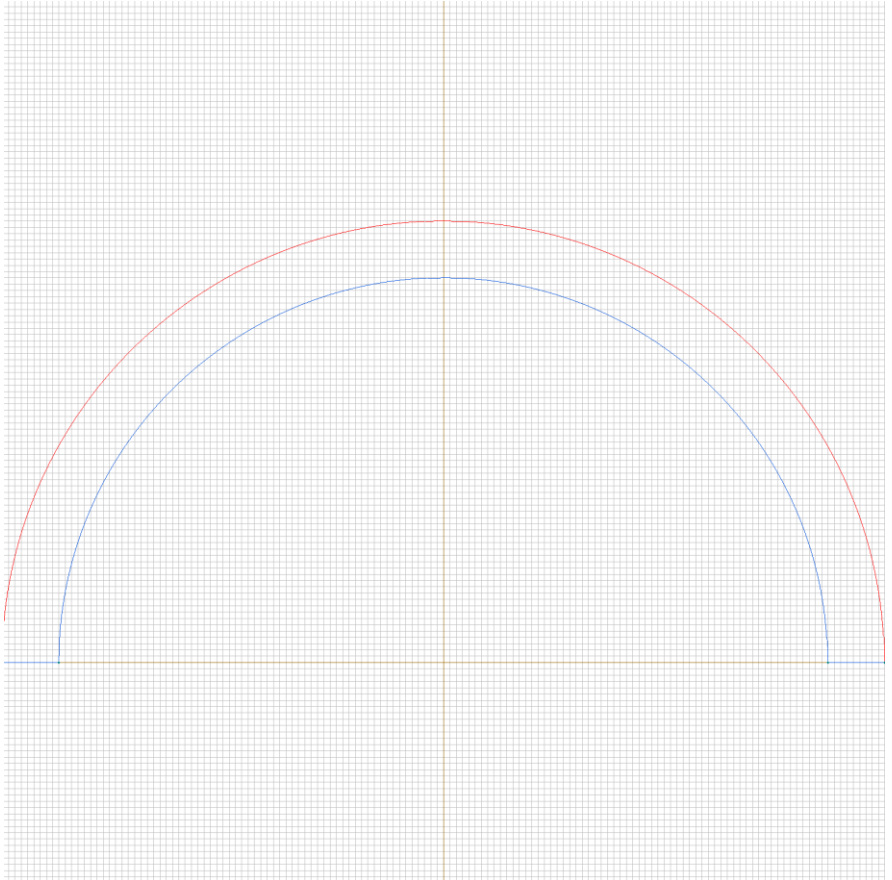

Results

Field lines

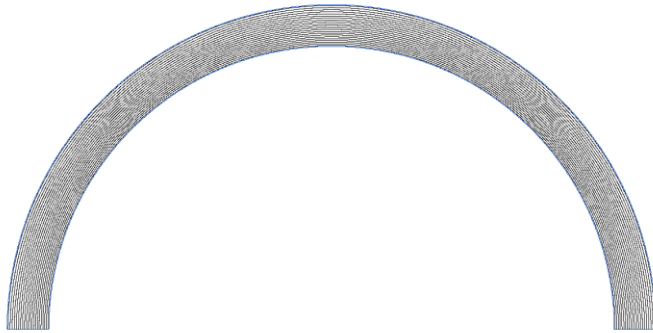

Results

Color map of Heat flux |F| [W/m2]

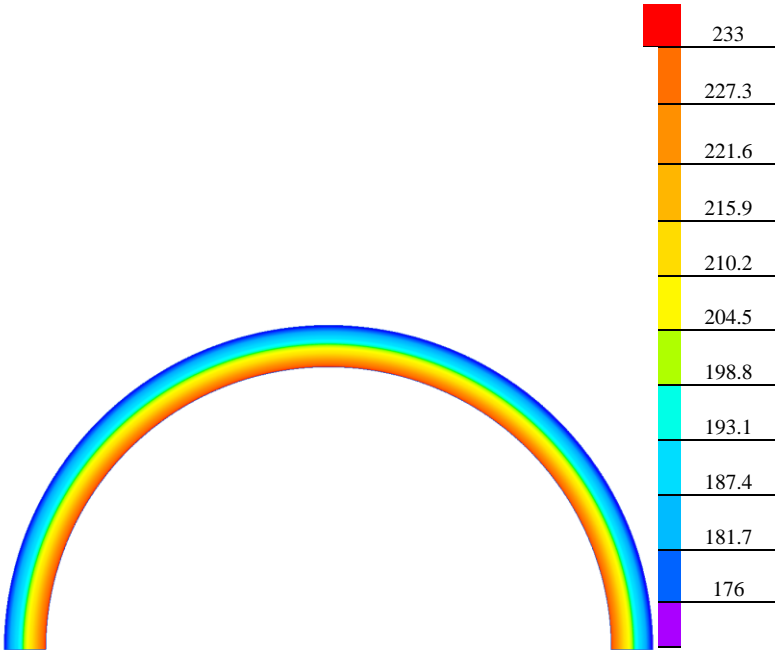

Nonlinear dependencies

No non-linear dependencies are used in this problem data